

Race Track Optimization

5/10/15

Team 3

Lucas Jaramillo

Fabian Gadau

Myrtle Lin

Bryce Thompson

Abstract

This design project will involve the optimization of the path a race car should take around a given automotive race track to minimize its lap time. The scope of this project is to model the most important subsystems of the car to predict its performance, after which it is possible to find the quickest path around a given racetrack based on an optimal path, optimal velocity profile and optimal user inputs. Comprehensive models of the subsystems will be used in order to constrain the maximum possible positions, velocities, and accelerations of the car. These include the incorporation of the vehicle's dynamics, traction, and powertrain as well as the track's geometry. The goal of this project is to provide an optimal path with velocity and user input profiles that are achievable for the car at each finite section of the track in order to minimize overall lap time. In the end different plausible routes and velocities will be analyzed to find an optimum path by applying true vehicle constraints, i.e. traction and dynamic limitations. The motivation of this project is to apply these techniques to aid the development of the vehicles designed by students at Arizona State University competing in the Formula Collegiate Design Competition hosted by the Society of Automotive Engineers. This project will also benefit the amateur drivers who are driving, so that they can be better prepared for competitive motor sports.

Table of Contents

1. Introduction	3
2. Problem Statement	5
3. Nomenclature	6
4. Track Geometry	8
4.1 Problem Statement	8
4.2 Mathematical Model	8
4.3 Model Analysis	9
4.4 Optimization Study	10
4.5 Parametric Study	10
4.6 Discussion of Results	10
5. Tire Pressure	13
5.1 Problem Statement	13
5.2 Nomenclature	13
5.3 Mathematical Model	13
5.4 Model Analysis	15
5.5 Optimization Study	16
5.6 Parametric Study	17
5.7 Discussion of Results	19
6. Vehicle Dynamics	20
6.1 Vehicle Dynamics Problem statement	20
6.2 Nomenclature	21
6.3 Mathematical Model	23
6.4 Model Analysis	24
6.5 Optimization Study	25
6.6 Parametric Study	26
6.7 Discussion of Results	26
7. Power Train	28
7.1 Problem Statement	28
7.2 Nomenclature	28
7.3 Mathematical Model	29
7.4 Model Analysis	32
7.5 Optimization Study	32

7.6	Parametric Study.....	35
7.7	Discussion of Results.....	36
8.	System Integration Study	37
8.1	AIO Approach	38
8.2	Usability of Results and Future Work	40
9.	References	41
10.	Appendix	42

1. Introduction

Following the most time efficient path a specific car can take around a real track can have a substantial impact on the success of a racing team. The most straightforward method to winning a race is to design the car that has the highest base performance figures and is tuned to the track as well as the most talented and focused driver behind the wheel. In most cases this is not the case and one has to make the best out of an imperfect situation.

The impact of these simulations can elevate the team above the competition. Every lap the race car has to drive around the track is taxing on both the components of the car and the budget of the team, so tuning a few of the car's subsystems before a lap is ever driven on the track can drive down the cost and work substantially. On the driver side, it is often difficult to quantify how good a race driver is, as well as how to improve the performance of said driver other than communicating that he should push harder in a certain sector. Knowing the ideal line, velocity and inputs that the driver should make makes quantifying improvement suggestions simpler. Because of the high number of subsystems and limited time and experience of the members of this team, the scope of this project must be limited to a few of the most important subsystems of the car.

The paper has a built model with 4 different subsystems to optimize the fastest lap time around a track. The model will be divided into four subsystems:

1. Track Geometry
2. Tire Model
3. Vehicle Dynamics
4. Powertrain

To optimize the fastest race path and time, assumptions are made as follow:

1. The geometry is rigid.
2. The car travels within the upper bounds and lower bounds of the track.
3. The car has front wheel steering.
4. There is constant tire contact with pavement, so no tilt steering will happen.

Using these models and assumptions, a MATLAB tool will be created to determine the fastest path around the track. The displayed output data will determine if it can be achieved and controlled by a human driver.

Subsystems Considered

a. Track Geometry

To generate meaningful data from the track the real geometry of the track must be available. The track will be generated in MATLAB with cubic spline function. Then the initial path will be picked at random as long as it is within the lower bounds and upper bounds. The different paths will give a derivative of time elapsed between points. The different paths will vary due to the users speed, turn of the steering wheel, change the of the gear, or a combination of the three. This result will be expanded with many options over the course of the track and gives an estimate of the time required for one lap. The model will use the power train, traction, and vehicle dynamics as well as static environmental values to bind the possible options the user can take.

b. Tire Pressure

The Tire pressure model will take into account the speed of the vehicle at any given time on the track. It will then combine that data with the pressure in the tires in order to determine the frictional coefficient between the vehicle and the track. This frictional coefficient will be used in the vehicle dynamics model in order to determine the maximum speed at which the car can travel at any given point of the track, especially in turns. This subsection will allow us to determine the optimal tire pressure by altering the pressure in the tires and determining how it will effect lap times.

c. Vehicle Dynamics

The car can only handle a finite amount of angular acceleration before the driver is either forced to break in a non-ideal location or lose traction. This occurs when the angular acceleration of the car is greater than the amount of traction that the tires can handle. The vehicle dynamics model relates the tire model, powertrain, and track geometry data in order to determine the current information regarding the vehicle's angular acceleration into one single subsystem. Furthermore, this model optimizes the suspension stiffness in order to lower the angular force seen on the tires, hence maximizing the powertrain output by minimizing the resulting lateral forces seen as a steering byproduct.

d. Powertrain

To properly model the acceleration of the vehicle in the forward direction, powertrain must be considered and modeled. We are using information such as the gear ratios, and wheel size from the internet given the Subaru STi that we are using for testing. The model optimizes the location of the gear changes, where to brake, and the throttle position, to make sure the car can achieve the modeled velocities.

2. Problem Statement

There is a huge population interested in fast racing, but only one in millions make it to the fastest race track. With the lack of experience and hands on application, many miss out on an opportunity to drive like a professional. In order to be the fastest one around a race track, one must have professional skills and experiences that help guide them through the process. Professional racecar drivers make decisions based on intuition and experience to determine their desired acceleration through turns and during straightaways.

Therefore, this model will allow inexperienced individuals to know the optimal path and places for car adjustments to allow the fastest time around the race track with minimal racing experience. By looking at the traction, vehicle dynamics, powertrain and the modeled track geometry will allow users to know the best coefficients to use on their actual cars. The optimal solution for the traction, vehicle dynamics, or powertrain may not be the optimal solution when these four subsystems are put together.

A race track can be modeled in a two- dimensional model or three- dimensional model. For simplification purposes, this model will first concentrate on a two-dimensional model. If time permits, a three-dimensional model will be created to better mimic a true racing situation on a race track.

3. Nomenclature

The nomenclature documented in this table is the overall nomenclature that will be used throughout the entire project and is made up of all the individual subsection nomenclatures. Some subsections have a larger nomenclature than others and maybe restated in the individual subsection.

Symbol	Definition	[Unit]
W_t	Vehicle Weight	[lb]
a_g	Gravitational Constant	[ft/s ²]
F_n	Normal Force (vertical)	[lbf]
h_s	Sprung Weight Center of Gravity Height	[in]
Z_f	Roll Center Height (Front)	[in]
Z_r	Roll Center Height (Rear)	[in]
p_d	Sprung Mass Weight Distribution from Front Wheels	[%]
W_s	Sprung Vehicle Weight	[lb]
K_d	Wheel Track	[in]
$K_{f,r}$	Spring Weight – Front, Rear	[lbf/in]
F_f	Frictional Force	[lbf]
F_c	Centripetal Force	[lbf]
A_c	Lateral Acceleration	[in/s ²]

M	Roll Moment	[in-lbf]
F_m	Spring Force	[lbs]
X	Spring Compression due to Body Roll	[in]
P	Tire Pressure	[psi]
V	Velocity	[mph]
μ	Tire/Track Frictional Coefficient	
t	Time	[s]
V_{vd}	Velocity bound based on Vehicle Dynamics	[kph]
V_{max}	Maximum Feasible Velocity	[kph]
dt	Δt based on distance velocity for step calculated	[s]
dx	Δx based on the path calculated	[m]
g_n	Gear ratio	[]
ω_{motor}	Rotations per minute of motor	[rpm]
dt_{gc}	Time since gear change began	[s]
p_t	Position Throttle	[%]
C_u	Gear change up procedure in progress	[Boolean]
C_d	Gear change down procedure in progress	[Boolean]
r_{wheel}	wheel radius	[m]
$r_{transmission}$	transmission ration	[]

4. Track Geometry

4.1 Problem Statement

The goal is to optimize the fastest lap time and path with changing vehicle dynamics at each position of the track.

Minimize: Lap Time

Subject to: Changing Velocities

The track geometry model incorporated the other subsystems before it could fully optimize the lap time. The initial track set up help provided the track curvature and track coordinates for the powertrain, tire model, and vehicle dynamics subsystem.

4.2 Mathematical Model

The consensus of the group was to first create a simple oval track. This was initially done by plotting ellipses and using a finite element analysis approach. How the track geometry is modeled in MATLAB is dependent on how each subsystem functions. With the change in how the subsystems would want to vary the initial guess the simple oval track was modeled differently in MATLAB.

The first path that was created was through a cubic spline by plotting 6 points. This track was initially a test track. It allowed each subsystem to understand where there mistakes may be in a less complex of a track. When this was done, the actual track (Musselman Honda circuit track) was modeled from acquired data. This was initially done by getting an image from the internet and modifying it so the image would only have the track that was run on. Then the image was inverted and the boundaries were shown. From this, it was undetermined how to acquire the function of the upper bounds and lower bounds of the track.

The next approach was to upload the image into Solidworks and get a good amount of points from the track. This resulted in 27 x and y coordinates each for the upper and lower bounds. This allowed the group to create gates between the track. With the points gathered, a cubic spline was done to connect the points of the track. Then within MATLAB, a smoothing function was done so the track would not be rigid. This was done by matching the first and second derivatives with the first and last point of the track. When the track was done being inputted, modifications were done to eliminate oddly shaped corners. Shown below is the final track with the gates created.

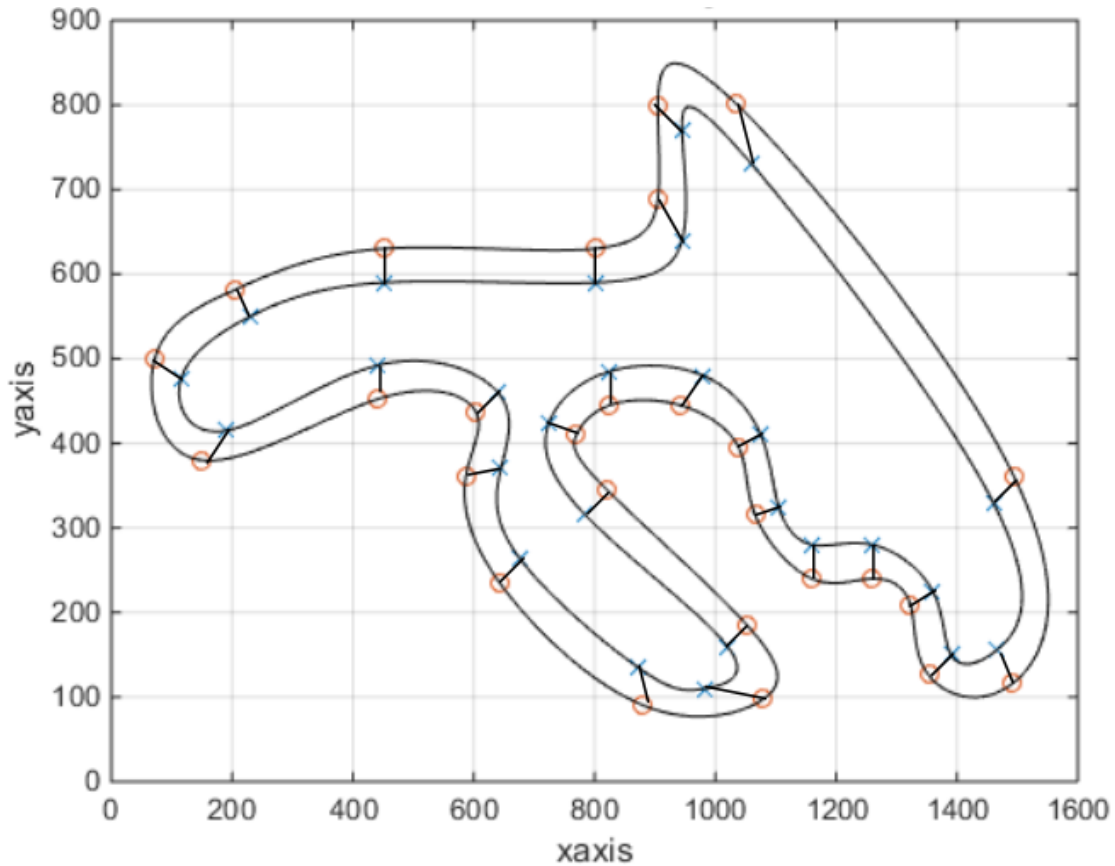

Figure 4.2.1 Track Geometry

Overall, instead of using a finite element approach, an angular cubic spline approach was taken. By taking a cubic spline approach, there will be infinite paths for the car to travel within the bounds of the track that can be easily evaluated using the gradient method. The cubic spline outputs points for the upper bounds and lower bounds of the track. When the initial guesses and changes to the guesses are taken, points will also be outputted and given to the remaining subsystems.

4.3 Model Analysis

Constraints on the path of the car was that it must travel within the upper bounds and lower bounds of the track. Of course, the upper bounds and lower bounds of the track cannot be achieved when the actual car is racing, so an inequality constraint was done to have the car be greater than the lower bounds but less than the upper bounds. With the created gates in our track, the lower bound was able to be assigned when lambda was zero and the upper bounds was when lambda equaled one.

The initial guess was the center of the track and lambda equaled 0.5. After the initial guess the information was passed through the various subsystems and given back to the track geometry. The track geometry path changed between iterations to find the fastest velocities at each point which will correlate to the fastest time. The inputs of the system will be given from the designers.

4.4 Optimization Study

The optimization of time could not have been acquired until the powertrain, tire model, and vehicle dynamics section was running. The initial optimization problem was going to be done through fmincon, but since the function of the track was never defined as a regular function it caused complications. The purpose of these created gates was that it estimated the next path between gates. As the estimated path changed, the gradients from one gate to another changed as well. This allowed the team to find the different times as the path slightly changed. A gradient method and Armijo Linesearch were implemented into the code to find the fastest overall lap time through these gates. Since the track data implemented a gradient function for the gates, Linesearch was also implemented using the gradient function. Linesearch ensured that the time found was less than the time found through the gradient method. If this was not done, then the initial alpha (step direction) was cut in half.

4.5 Parametric Study

The optimum lap and time changes as the upper and lower bound parameter changes. The length and complexity of the track also effects the lap time. The optimization will take longer with a more complex track because there will be more gear and velocity changes. Therefore, results cannot be generalized since they are dependent on how the track is outlined. At the same time, ranges of parameter values cannot be predicted for any solution. Shown below are results from a simplified track and in future sections results from a more complex will be shown and discussed.

4.6 Discussion of Results

The optimization of all the codes together was first done to a simplified track. The sampled racing lines shown below could only be realistic racing lines. Below are results from the simplified model to ensure that the compiled codes worked.

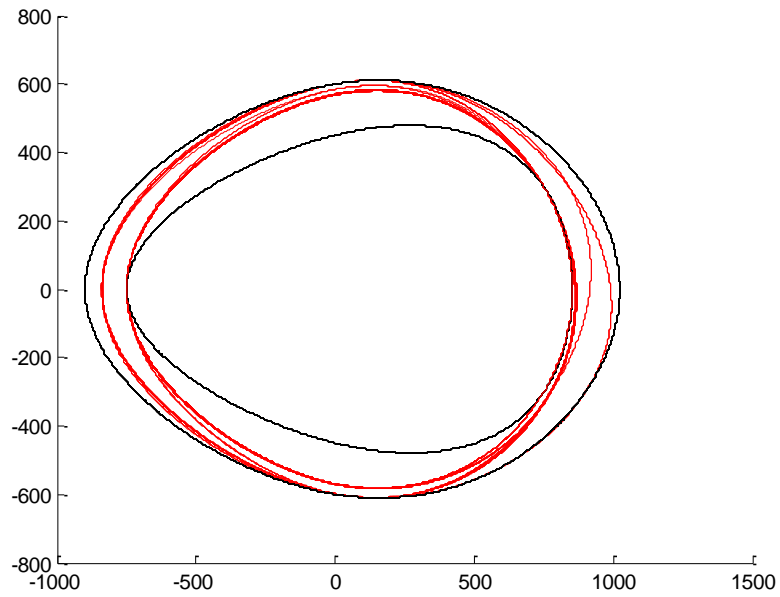

Figure 4.6.1 Sampled Racing Lines

The simplified track only had 6 gates. Below the optimization results show how the implemented gradient method and Linesearch affected the lap time with every iteration.

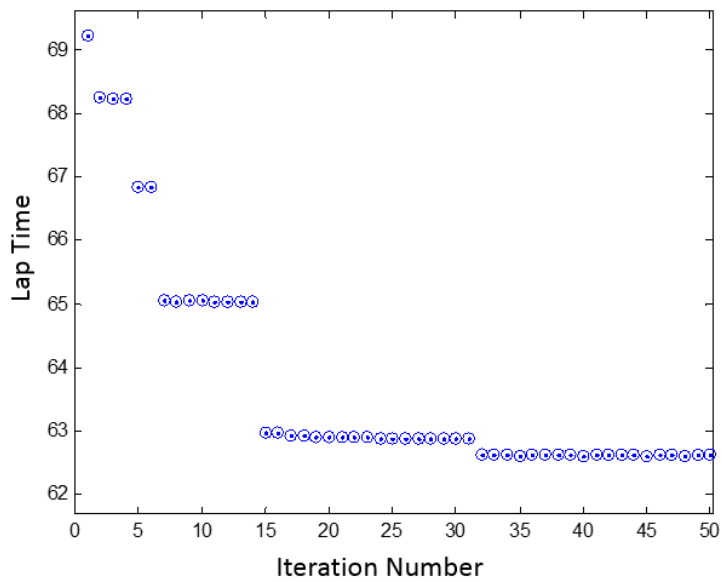

Figure 4.6.2 Optimization Results

The paths were usually bounded by the track or powertrain. Two local solutions were able to be found. Path one took 62.6 seconds and ran along the outside of the track. While path two took 64.2 seconds and ran on the inside of the track.

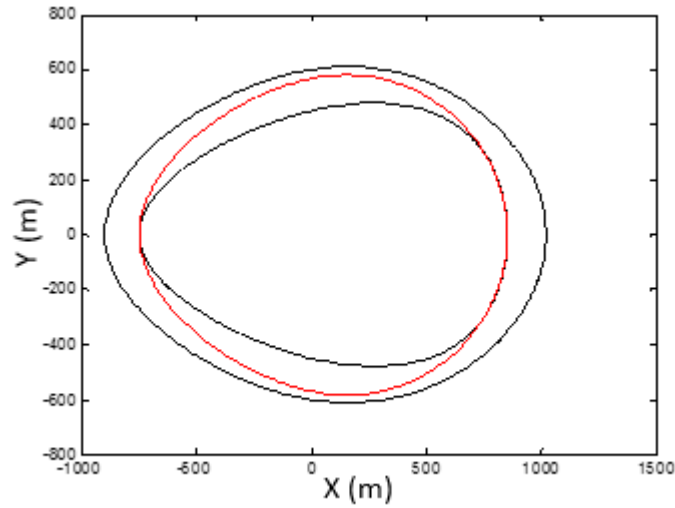

Figure 4.6.3 Path 1 Results

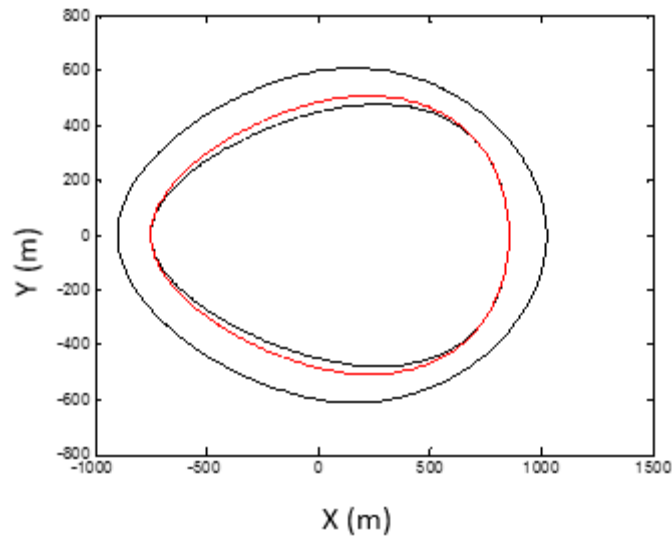

Figure 4.6.4 Path 2 Results

These two local solutions are expected racing lines that could happen. These path data will allow a driver to know the fastest way around a track or the best way to surpass someone on the track. The solution accounts for shifting gears, full throttle, and is limited to the vehicle dynamics.

5. Tire Pressure

5.1 Problem Statement

When attempting to optimize the time it takes a car to go around a track it becomes very important to look at what kind of traction the tires will have on the pavement. The traction ultimately determines the speeds that the car can handle while going around a track. Before a race starts tire pressure is one of the few things that can be adjusted in order to best help with how a car rides and the traction it makes with the track. Traction is typically higher at low speeds with higher tire pressure and higher at high speeds with low tire pressure. So depending on track dimensions and the speed ranges at which the car will travel different pressures will be better or worse. In this subsystem we will create a model that outputs a tire/track frictional coefficient for all possible velocities with a given tire pressure. Currently there are no working mathematical models that we are aware of that perform this function. We will be using data collected by The Department of Motor Vehicles to create a META model that we can then integrate into the rest of the subsections in order to get the fastest lap times.

5.2 Nomenclature

Symbol	Quantity	Unit
P	Tire Pressure	[psi]
V	Velocity	[mph]
μ	Tire/Track Frictional Coefficient	
t	Time	[s]

5.3 Mathematical Model

Objective Function

The goal of this subsection is to find the optimal tire pressure that can be used in the tires in order to minimize the time it takes for the car to travel around the track. In order to find the optimal pressure all the other subsystems will need to be used. This subsystem will vary the pressure and use a set of velocities around the track to find track times for each tire pressure and then select the pressure that results in the fastest lap time.

Minimize: $t=f(P, V)$

Constraints

Physical Constraints

The tire pressure is naturally constrained by how much pressure a tire can safely hold. For this model we used data from The Department of Motor Vehicles so I have chosen then upper and lower bounds for tire pressure to match the max and min pressure tested in that data. These constraints are denoted by G1 and G2.

$$G1 = 17 - P \leq 0$$

$$G2 = P - 35 \leq 0$$

Engineering Constraints

The other constraints to take into account are the max and min velocities at which the car can travel at while going around the track. We can assume that the car will never go in reverse so we set the lower bound for velocity at zero. The upper bound for velocity is to be determined by the other subsystems and the mechanics of the vehicle. These constraints are denoted by G1 and G2.

$$G3 = V - (TBD \text{ MAX VELOCITY}) \leq 0$$

$$G4 = -V \leq 0$$

Summary Model

In summary the two part goal to this subsection is first to work with the other sections in the overall model and to provide frictional coefficients that will be used with the vehicle dynamic section. The second part of the goal will be to be able to optimize tire pressure for a track in order to determine the optimal tire pressure that will provide the fastest possible lap times.

Minimize: $t=f(P, V)$

Subject To:

$$G1 = 17 - P \leq 0$$

$$G2 = P - 35 \leq 0$$

$$G3 = V - (TBD \text{ MAX VELOCITY}) \leq 0$$

$$G4 = -V \leq 0$$

5.4 Model Analysis

The model for this subsection was developed using data to form a 3 dimensional META model. This simplified model only takes into account velocity and tire pressure to determine tire/track frictional coefficients. Tire pressure is bounded by the amount of pressure the tire can theoretically hold. At no point in the race will the car be traveling in reverse or at a velocity higher than it is capable there for it is bounded at these velocity. We determined some of these boundaries using the range of test data from The Department of Motor Vehicles as the boundaries. This model is no linear so a general statement of how velocity and pressure will affect track times cannot be made. This is displayed below in a monotonicity table.

Monotonicity Table

	V	P
t	?	?
G1		-
G2		+
G3	+	
G4	-	

Since we are optimizing for time the optimization problem for this section had to be performed using the other subsections of the overall optimization problem. In order for the optimization to run smoothly some simplifications had to be made. The initial guess for the velocities the car travels on the first lap was made using an assumption that the car could never travel at speeds that would cause the car to feel more than a 1G force. The frictional coefficients don't affect the speed of the car in the overall model until the centripetal force of the car becomes greater than the frictional force of the car. In order to have the greatest influence from this subsection for running the tire pressure optimization I increased initial guess for velocities around the track. It should also be noted that the tires are assumed to not deteriorate over time thereby changing frictional coefficients over time.

5.5 Optimization Study

The optimal tire pressure was found to be 20.7 PSI both graphically and using Matlab's built in fmincon function. Once all the subsections were put together for the overall optimization I was able to vary the tire pressure on a set path around the track and examine how it affected track times. Figure 5.5.1 below displays the path that was used for this optimization.

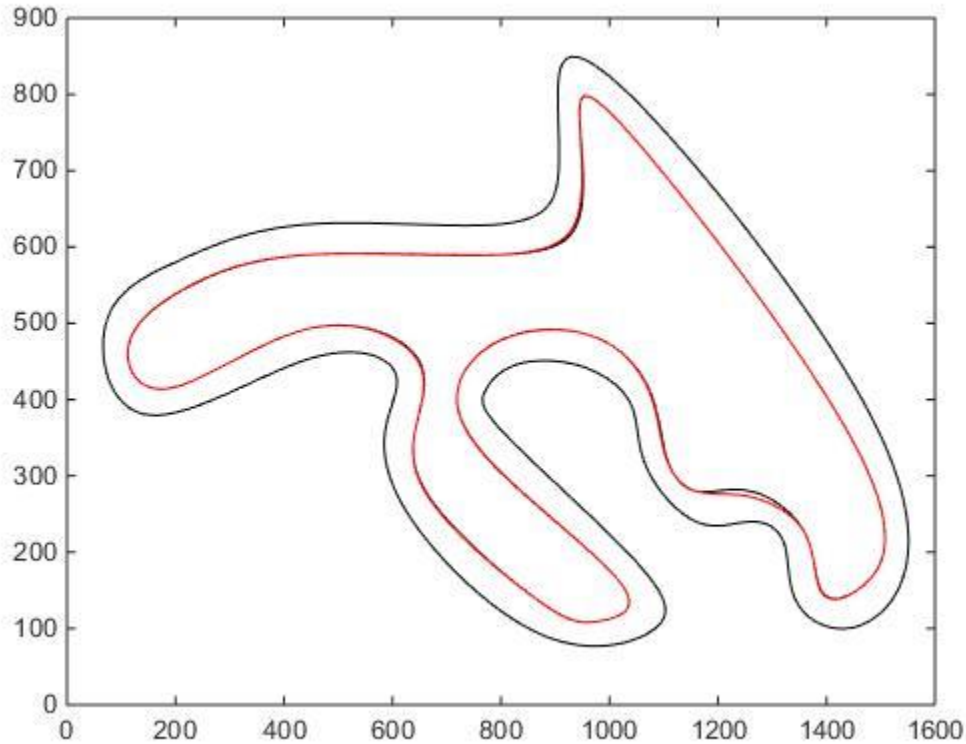
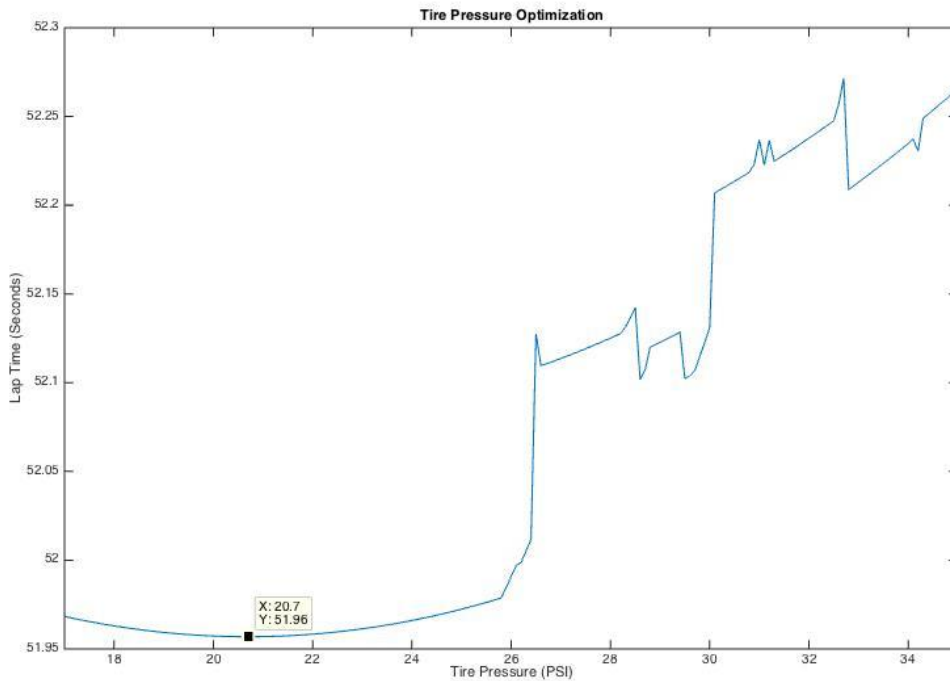

Figure 5.5.1

The path follows closely around the inside of the track since I eliminated the 1G initial assumption used for the velocities as I mentioned in the model analysis section. Using this path and by varying the pressure in the tires from 17 psi to 35 psi I collected data on the time it takes to complete a single lap on the track. Figure 5.5.2 displays the data collected during this process.



Figure

Figure 5.5.2 Results from Optimization

These results were then verified using Matlab's built in fmincon function with various initial guesses. Table 5.5.1 shows the results using fmincon.

Initial Guess (psi)	Pressure (psi)	Lap Time (Seconds)
17	20.6954	51.9568
26	20.6953	51.9568
35	20.6957	51.9568

Table 5.5.1 Results from fmincon

5.6 Parametric Study

As I ran the tire pressure optimizations one of the biggest parts of the code that had to be adjusted was the part that guessed the initial velocities based on G-force as discussed. For the solution found above I scaled the guess by a factor of 10 but to avoid extreme velocities I set a limit on the upper bound for velocities of 80 mph. I kept the 80 mph cap for all my tests but I adjusted the scaling factor I used from 1 to 10. When I scaled the initial velocities by anything lower than 10 it resulted in flat spots on the graph. Figure 5.6.1 is the graph for when I used a scaling factor of 8.

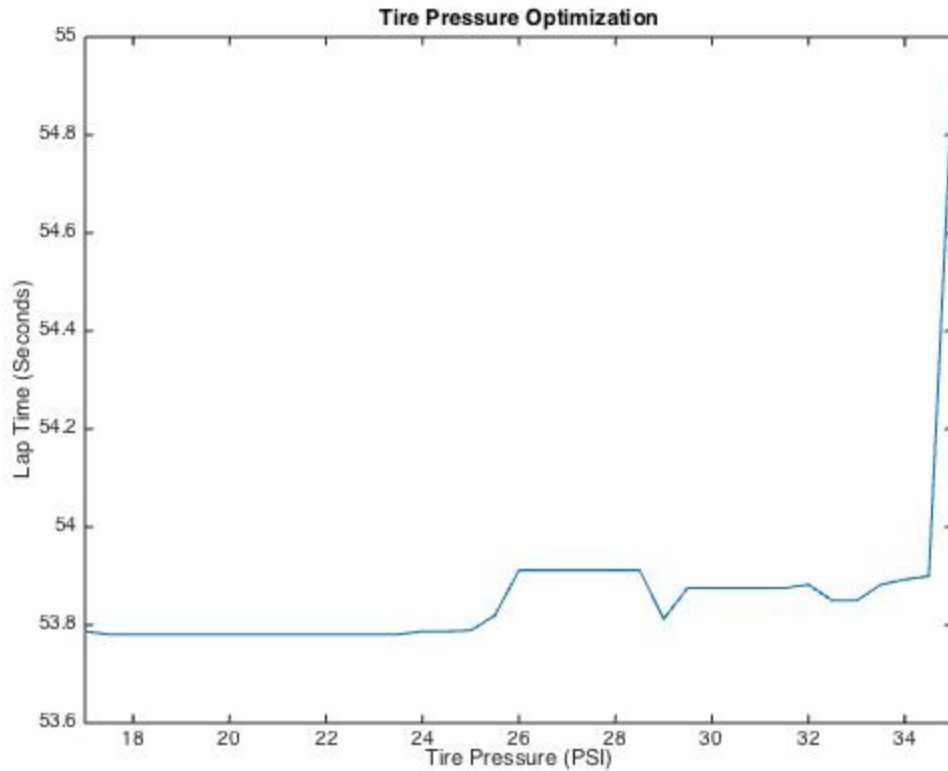

Figure 5.6.1 Data with Scaling factor of 8.

This data didn't allow for a good optimization to be found. The graphs also became more flat with lower scaling factors. This is due to the low initial guess for velocities. At low speeds the centripetal force is never greater than the normal frictional force of the car and so the velocity of the car is never limited by the frictional force and thus pressure would have no effect on lap times. When these flat spots occurred fmincon would always give different optimal pressures depending on the guess used with the fmincon function. Table 5.6.1 displays the results for various scaling factors.

Scaling Factor	Optimal Tire Pressure			Graphically
	Fmincon w/ Guess of 35 psi	Fmincon w/ Guess of 35 psi	Fmincon w/ Guess of 35 psi	
10	20.6957	20.6953	20.6954	20.7
8	33.9244	26	18.2575	17.5
6	34.01	26	17.99	33.6
4	34.01	24.2454	20.5319	31.8-35
2	34.01	26	17.99	17-35
1	34.01	26	17.99	17-35

Table 5.6.1 Results with Various Scaling Factors

5.7 Discussion of Results

The result of 20.7 psi found from this optimization is largely due to the track geometry we used for this model. These results cannot be used as a generalization for tire pressure in any given tire on any given track. It is assumed that if we were to use data from a different tire the results would be different. Since the optimal tire pressure found did not occur at the boundaries it cannot be simply stated based on this optimization that a lower tire pressure is generally better than a higher pressure or vice versa. The solution of 20.7 psi makes sense for this car, with these tires, on this track since it fell within the constraints of problem. In order to improve the solution found we could reassess how we set the initial guess for velocities around the track. The model could also be made much more complicated by not just looking at the lateral frictions but also the friction in the longitudinal direction and how it would be integrated with the power train model.

6. Vehicle Dynamics

6.1 Vehicle Dynamics Problem statement

To optimize the spring stiffness of the test vehicle based on the optimized projectile path and velocity profile.

The vehicle dynamics model plays distinct roles throughout the course of the project. During the initial phases of the racetrack path optimization, the vehicle dynamics model serves as a series of physical relationships which calculates the highest attainable instantaneous velocity based on the path curvature, estimated projectile velocity and tire pressure along with the corresponding frictional coefficient between the tires and the pavement. Throughout this portion of the vehicle dynamics model, the spring stiffness is set to the current actual value of that of the actual test vehicle. Once the projectile path has been optimized, an independent optimization study is performed on the vehicle dynamics model which is constructed of slightly more complex relationships which describe the body roll and allow the spring coefficients to be treated as the design variables. This model is described in detail throughout the following sections.

6.2 Nomenclature

Symbol	Definition	[Unit]
W_t	Vehicle Weight	[lb]
a_g	Gravitational Constant	[ft/s ²]
F_n	Normal Force (vertical)	[lbf]
h_s	Sprung Weight Center of Gravity Height	[in]
Z_f	Roll Center Height (Front)	[in]
Z_r	Roll Center Height (Rear)	[in]
p_d	Sprung Mass Weight Distribution from Front Wheels	[%]
W_s	Sprung Vehicle Weight	[lb]
K_d	Wheel Track	[in]
$K_{f,r}$	Spring Weight – Front, Rear	[lbf/in]
F_f	Frictional Force	[lbf]
F_c	Centripetal Force	[lbf]
A_c	Lateral Acceleration	[in/s ²]
M	Roll Moment	[in-lbf]
F_m	Spring Force	[lbs]
X	Spring Compression due to Body Roll	[in]
Θ	Body Roll	[Degrees]
F_s	Side Wheel Force	[lbs]
V	Velocity	[ft/s]
h_{rm}	Sprung Weight Moment Lever Arm	[in]

F _m	Spring Force	[lbs]
D	Distance from updated Center of Gravity to Wheel	[in]
R	Turn Radius	[ft]

$$A_c = \frac{v}{r * a_g} \quad (1)$$

$$h_{rm} = h_s - (Z_f - (Z_r - Z_f))(1 - p_d) \quad (2)$$

$$M = h_{rm} W_s A_c \quad (3)$$

$$F_m = \frac{M}{h_{rm}} \quad (4)$$

$$x = \frac{F_m}{2K} \quad (5)$$

$$\theta = \tan^{-1} \left(\frac{x}{h_{rm}} \right) \quad (6)$$

$$d = \frac{K_d}{2} - x \quad (7)$$

$$F_s = \frac{2M}{d} \quad (8)$$

$$F_f = \mu F_n \quad (9)$$

$$F_c = \frac{W_t}{a_g \left(\frac{v^2}{r} \right)} \quad (10)$$

$$v = \sqrt{\mu a_g r} \quad (11)$$

$$F = \frac{(k_f + k_r)x^2}{2} \quad (12)$$

6.3 Mathematical Model

The goal of the vehicle dynamics model is to study the motion of the vehicle throughout the projected path and to calibrate and optimize the suspension stiffness that will best suit the vehicle's body roll according to the nature of the vehicle's route and inputs. In other words, finding the optimal front and rear spring coefficients in equation (12), namely Hooke's Law. Mathematically, the vehicle dynamics system has three major system constraints, consisting of the tire traction, body roll and available suspension travel, pertaining to equations (9), (6) and (5), respectively. Refer to appendix for model modifications.

The vehicle dynamics *simulation* subsystem model essentially studies the lateral forces involved with the vehicle's motion. Due to a lack of testing instrumentation, this model strictly relies on physical models which determine the leading factors that directly impact the velocity of the projectile. The simulation portion of the vehicle dynamics model takes into account the initial vehicle velocity guess, tire pressure, frictional coefficient between the pavement and tires along with the curvature of the track in order to calculate the maximum achievable velocity throughout the given corner.

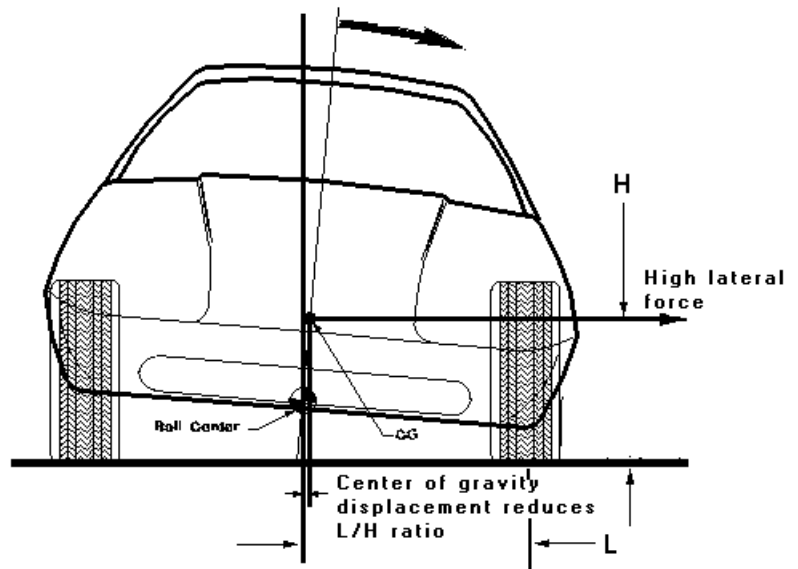

Furthermore, the simulation subsystem provides the optimization model with more detailed physics which provide the necessary information to accurately model the suspension parameters $[k_f k_r]$. An important concept to note for this section is that the vehicle was modeled as a spring/mass system for convenience; A true vehicle dynamics model is much too complex for this level of analysis required for this subsection, which would realistically involve time dependent fluctuations in the spring/damping system, heat transfer and fluid viscosity calculations, mass transfer along with other high order differential equations. For the purpose of this report, the essential physical relationship involved in this subsystem is to track the motion of the swaying center of gravity. Based on the true vehicle geometry, a simple mass and spring model was formulated in order to approximate the forces involved with the vehicle's body motion, which rotates around a "roll axis". This rotation produces a centripetal force that results directly upon the tires, which are bounded by the tire traction model's predicted frictional

coefficients. The model then sums the forces which act upon the tire, causing an increase in tire pressure, hence a variation in frictional coefficient, along with the forces seen by the suspension components in order to perform the system's optimization task.

To summarize, the vehicle dynamics model plays two major roles. The simulation role corrects the predicted cornering velocity by inputting the variables V , P , μ and r (velocity, pressure, frictional coefficient and track curvature) and outputs the corrected cornering velocity, V . The true mathematical model for the optimization procedure takes in the resultant forces from the constrained simulation model and optimizes the spring stiffness coefficients.

6.4 Model Analysis

As mentioned in the previous section, the system's model is substantially simplified by describing the vehicle's lateral motion via spring and mass relations. A few of the major assumptions which simplified the physics involved can be found below.

- No dampening effects – No fluid, heating nor time dependence involved in the suspension.
- Tire forces only account for an increase in tire pressure – No change in contact area nor heating effects.
- Immediate body mass response – This eliminates any time dependent or force memory involved in the body sway.
- No rotational momentum storage as the inflection point varies.
- Tire sliding is not achievable (This point acts as a model constrain).

6.5 Optimization Study

The optimal spring rates shown below are the results which were achieved by fitting the suspension reactions as the vehicle underwent turns, to the actual suspension geometry. This was performed by essentially fitting all of the individual suspension travel readings (forces pertaining to 2001 points) into Hooke's model while allowing the suspension stiffness to be variable, in order to avoid full suspension compression. This task was performed by using a user defined gradient step method.

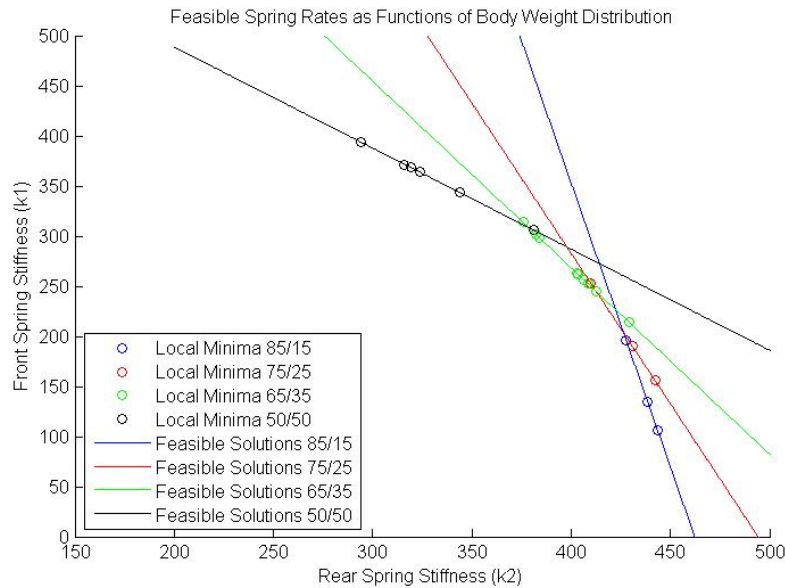

Figure 6.5.1 Local minima solutions to Hooke's model. The plot shows the front and rear spring stiffness combinations that work with the given projectile path and forces seen on the suspension to avoid bottoming out the suspension travel and absorb the majority of the energy involved in the body motion.

In order to create more interesting results, the body weight distribution was varied over different optimization runs; the numbers seen in the legend correlate to the front/rear vehicle weight distribution.

6.6 Parametric Study

The model converged on various local minima as the initial guess points were varied. The following table provides the results from the variation for the common 65% front, 35% rear weight distribution analysis.

Distribution	Initial Guess	k1	k2
65/35	70/70	408.82	252.45
65/35	100/150	382.17	301.94
65/35	80/80	406.89	256.02
65/35	10/50	403.69	261.99
65/35	25/125	375.75	313.87
65/35	125/50	429.53	213.98
65/35	50/50	412.67	245.29
65/35	100/100	403.05	263.18
65/35	80/135	383.94	298.66

Table 6.6.1 Local minima achieved as the result of initial guess variation. Note that some of the initial guesses result in a duplicated local minima.

Due to the linear relationship seen in the spring stiffness solutions, the feasible solutions are fairly predictable. This predictability makes sense given that if the spring rate is relaxed on one side of the vehicle, the opposite will require a higher spring rate in order to effectively absorb the energy produced throughout the cornering process, providing a linear range of feasible solutions to each vehicle weight configuration.

6.7 Discussion of Results

The results of the optimization study are slightly higher than the actual spring rate found in the modeled vehicle (220 lbf/in front and 185 lbf/in rear) which is mostly due to the over simplification of the physical process that truly occurs in a vehicle. The trends make perfect sense and the graph below will provide further insight to these numerical values.

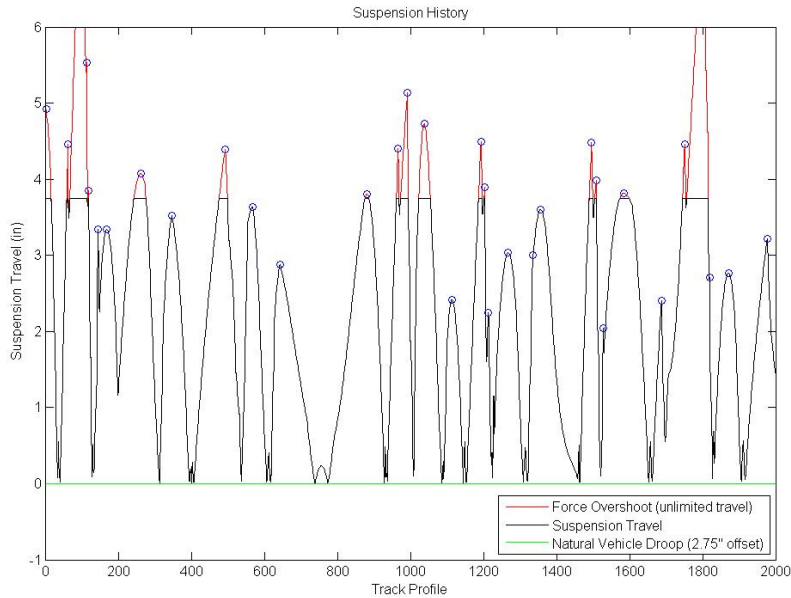

Figure 6.7.1 Shows the total theoretical suspension travel seen by model throughout the course of the track. The suspension travel is calculated from the body roll force and momentum equations.

The true suspension of the vehicle has a total of 6.00” inches of travel, of which 2.75” are consumed by the sprung weight of the vehicle, leaving 3.25” of available spring travel to absorb energy throughout the cornering process. The red portion of the graph suggests that the original suspension stiffness experienced loads that were too high to handle, which in practice would cause the suspension to bottom out and send the force to the tire, which essentially works against the grip and causes premature sliding.

The optimization model takes these forces into account and optimizes the coefficient so that the suspension is will never bottom out throughout the course of the projectile, hence the higher spring coefficient values. Any of the local minimum solutions that are shown in **table 6.6.1** are acceptable values for the current global system.

7. Power Train

In many cases optimizing the powertrain is an extremely costly endeavor that requires testing, manufacturing or control system knowledge. In this sub problem the focus of the optimization was therefore how the user (driver) interacts with the car. This allows a support team to give precise feedback to the driver to give him the best chance to beat the competition.

7.1 Problem Statement

Optimize the user interactions with the powertrain such as gear change timing, throttle position and brake pedal position to minimize lap times based on a predetermined path around a track.

7.2 Nomenclature

Symbol	Definition	[Unit]
V_{vd}	Velocity bound based on Vehicle Dynamics	[kph]
V_{max}	Maximum Feasible Velocity	[kph]
dt	Δt based on distance velocity for step calculated	[s]
dx	Δx based on the path calculated	[m]
g_n	Gear ratio	[]
ω_{motor}	Rotations per minute of motor	[rpm]
dt_{gc}	Time since gear change began	[s]
p_t	Position Throttle	[%]
C_u	Gear change up procedure in progress	[Boolean]
C_d	Gear change down procedure in progress	[Boolean]
r_{wheel}	wheel radius	[m]
$r_{transmission}$	transmission ration	[]

7.3 Mathematical Model

The mathematical model for the powertrain was based on test results of the car that was studied for the purpose of this course. This was a 2010 Subaru Sti with a Cobb Stage II tuning kit. The power and torque curves for this car are as seen in the figure below.

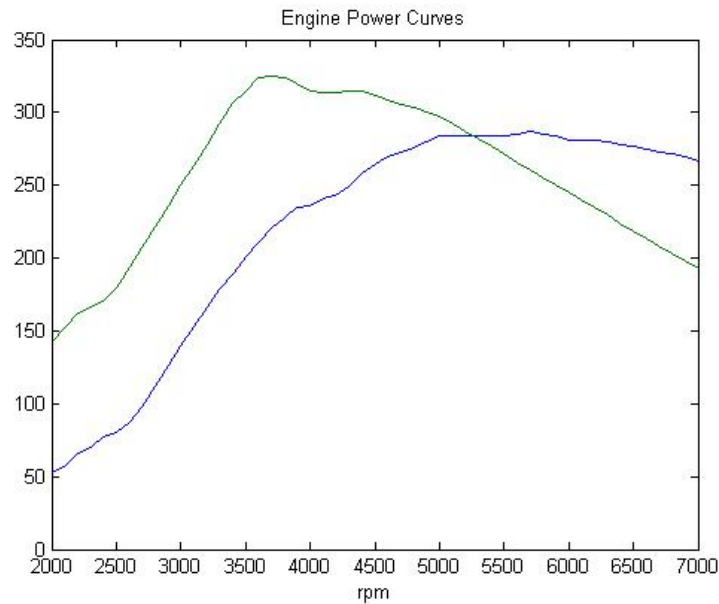

Figure 7.3.1: Engine torque(green) and power(blue) curves. What is seen at the wheel is affected by gear ratios and wheel geometries

This allowed us to calculate how quickly the engine could produce a change of speed based on the throttle position and what gear was currently selected. Because of the nature of the track, especially the lack of straights, only gears 1-4 had to be modelled.

Converting between rpm and vehicle velocity can be done using the equation 7.1 below.

$$V = \omega_{motor} / g_n * 2 * \pi * r_{wheel} * .06 / r_{transmission} \quad [7.1]$$

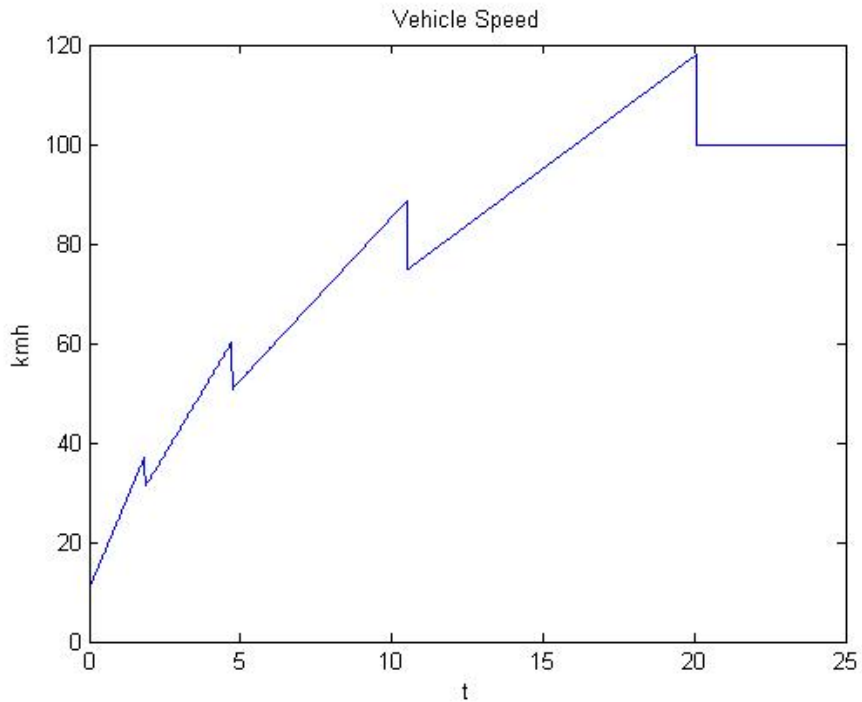

Figure 7.3.2: Speed of the car during acceleration. In this case the gear changes slow the car down due to lack of power.

There is a change in the slope of the velocity with respect to the gear that is selected. This is caused by the increased loads both due to aerodynamics, but predominantly the added momentum that must be moved per change in rotation of the engine.

The actual variables were calculated at every time step and are based on information from the previous step (previous motor speed, gear, gear change Booleans, time since gear change procedure was started) and information from the current step (dx, and maximum velocity based on vehicle dynamics).

The Initial guess on user interactions is based on output from a flowchart as seen below:

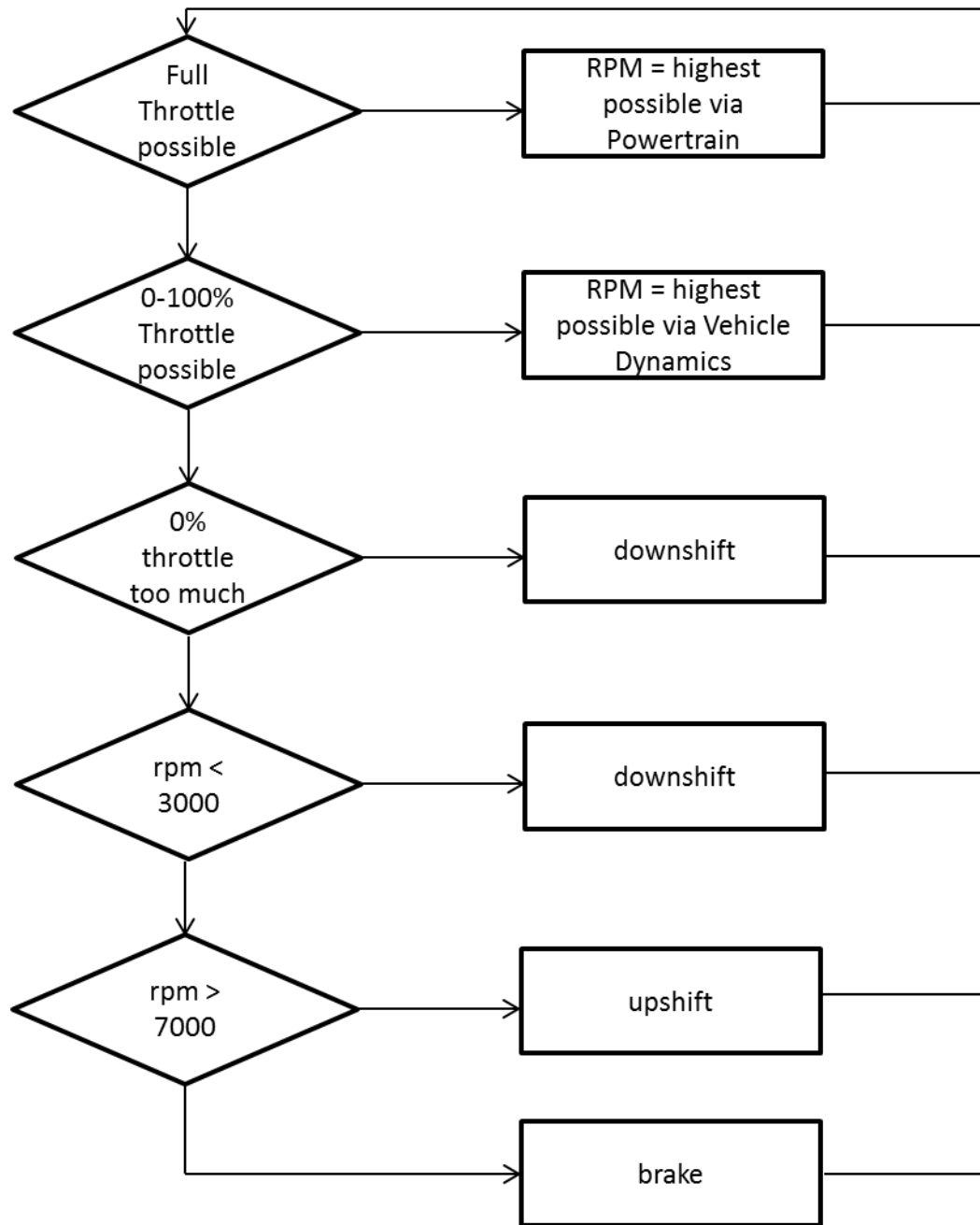

Figure 7.3.3: This simplified flowchart shows the algorithm that was used to create an initial guess for user interactions with the powertrain for each step.

The above initial guess algorithm created a few problems. The first of which was that in situations where the VD bound on Velocity decreased fast enough to where even braking was not able to keep it inside the vehicle dynamic bounds. This

was solved using a backtracking method that changed previous steps needed to comply with the VD bounds. This is extremely important as it ensures a viable situation based on the model.

The other problem was that the model sometimes quickly oscillated between two gears. This was solved by taking out gear changes that oscillated between two gear changes after the first change, if they happened quickly enough. This heuristic change made a huge impact on lap times.

7.4 Model Analysis

This model is an extremely simplified model of a drive train. This was done because we wanted to capture enough of the drive train characteristics to give a feasible solution, but spend the majority of the time focusing on optimization strategies.

At each step the model can either be bounded by the Vehicle Dynamic model or the Powertrain model or in many cases both. Formulated in a different way, the achievable velocity is bounded by the fact that the car can't go around corners at any speed, or that motor can't accelerate fast enough. Also, the car can be bound by both at the same time. This happens when the user has to place the throttle between 0 and 100%. These driving situations are the most difficult for the driver, because he has to keep track of two bounds. It is in these sectors that the most time can be gained.

7.5 Optimization Study

To optimize the location of gear changes, the initial guess was based on the fastest feasible path around the track, which already included the lack of false oscillations of the gear changes.

The location of the gear changes were moved in either direction until a minimum time was found. To achieve this I chose to use a gradient based method. This was done by calculating the time around the entire track based on having a specific gear change in the original location, as well as having it in the location one step prior and one step later than the original.

If either the earlier or later gear changes were faster than the original one, then that one was chosen as the new central location. This was repeated until the central location was faster than the two adjacent. In almost all locations a few shifts were made. This can be seen in the next table.

Table 7.5.1: Gear Change Optimization Results

Gear Change Number	Number of Steps Shifted	Time Advantage (s) (+) <i>is good</i>
1	3	0.0311
2	0	0
3	2	0.0481
4	9	0.0789
5	1	0.0016
6	3	0.0027
7	0	0
8	0	0
9	3	0.0079
10	6	0.0634
11	7	0.0328
12	4	0.1085
13	0	0
14	6	0.0105
15	3	0.0232
16	3	0.0551
17	1	0.0013
18	0	0
19	0	0
20	3	0.7784
21	0	0
22	0	0
23	1	0.1546
24	0	0
25	2	0.0321
26	0	0
27	0	0
28	2	0.0555
29	2	0.0958
30	1	0.0044
31	2	0.0208
32	0	0
33	3	0.0126
34	1	0.1232
35	1	0.0009
36	0	0
37	2	0.0042
38	2	0.0027
39	1	0.0003

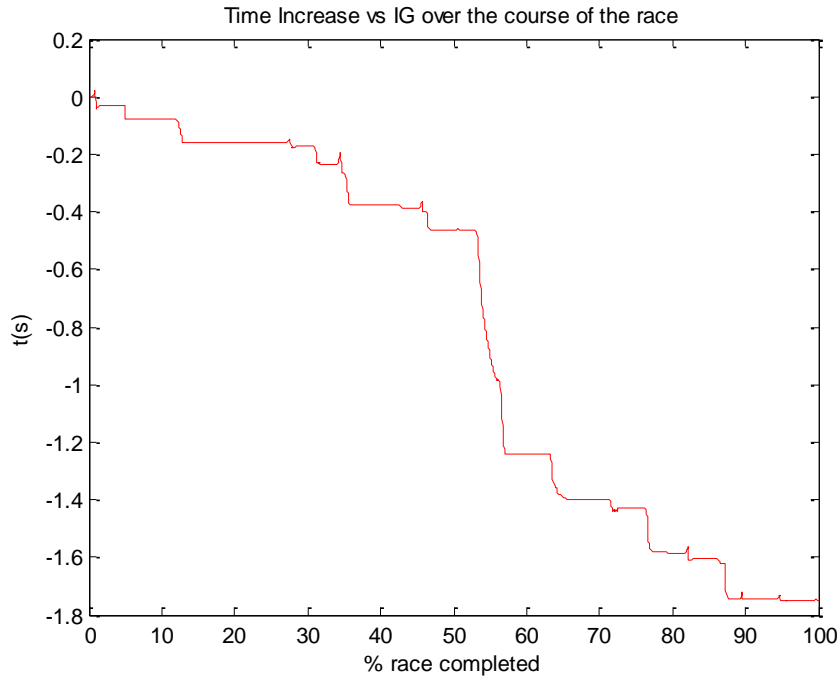

Figure 7.5.1: Time gained by optimizing gear changes compared to the initial guess

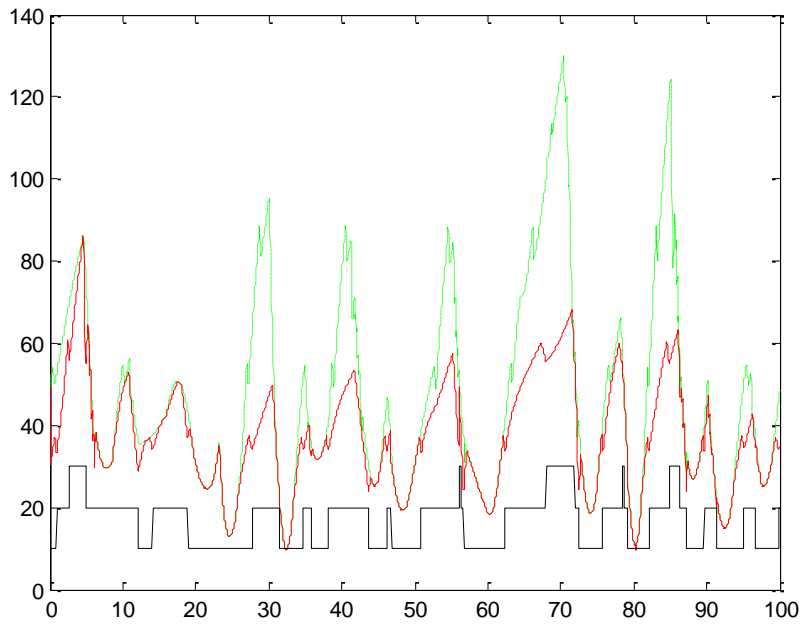

Figure 7.5.2: V_{bounds} based on Vehicle Dynamics (green) and actual velocities (red) during the race as well as the gears (black) at that location.

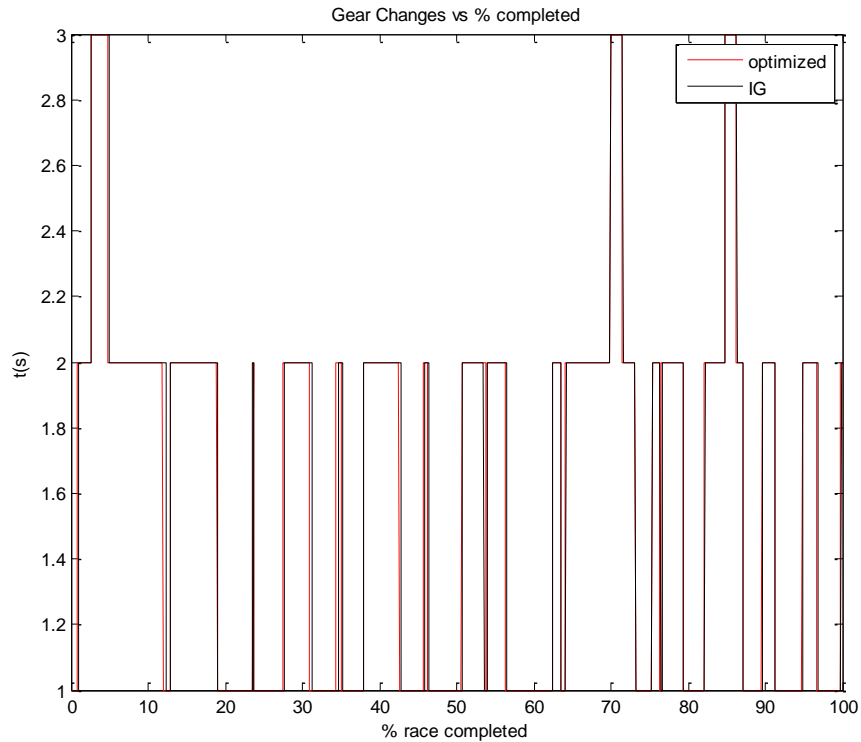

Figure 7.5.2: Gear Changes Optimization results.

7.6 Parametric Study

There are two major bounds to the powertrain model that increased the performance of the vehicle.

The first is the maximum rpm of the engine. In this case the engine is limited by the ECU to 7000 rpm. This is quite common for normal consumer engines, and the parts are made to last at the loads experienced here for the lifetime of the engine. If the components are upgraded, this number can be increased. A 100 rpm increase makes the lap 0.3146 second faster. This is why formula one and performance motorcycle engines operated in the 12-20 krpm range.

Second, increasing the throttle response increases the lap times. This can be achieved by reducing the weight of the components that are used inside of the engines, as they prevent the fast changes in rpms.

The results of the parametric study can be seen below.

Action	Result
Max. Rpm 7100 vs 7000	-0.3146 s/lap
Increasing throttle response by 1%	-0.0568 s/lap

7.7 Discussion of Results

The problem statement has been met. A model that predicts the performance of a powertrain and how it behaves with the user inputs has been created.

More importantly, after the initial guess was made a faster solution can be found by changing the location of the gear changes. This is especially efficient for race day applications, as there are few if any parametric changes that can be made on race day to change the performance of the vehicle. Those slight changes can have a profound impact on the race results as 1.7 advantages per lap are immense. In most scenarios this is enough to lap the competition, or keep up with much more expensive cars.

On another note, as the parametric study shows, changing physical components of the car can also have an effect on the performance. More importantly, this model can be used to predict the effect that a physical upgrade can have on lap times. This makes picking out components for engineers much simpler. Especially when budget is a limiting factor and one has to change between different options.

Lastly, the engine can undergo testing in a lab setting that mimics what is to be expected during a race. This can be used to stop the engine from creating unexpected problems during the race.

Opportunities for a better model are outlined below.

- Model the control system of the car used for throttle response
- Model the turbo, especially turbo lag at low rpms.
- Optimize the physical components to increase lap times
 - This is especially true of the gear box, which could be tuned for the specific race track.
- Increase the steps between states especially in areas that are important, such as when there are gear changes.

8. System Integration Study

To create viable results for the optimized times for the racetrack, the four basic models of the car have to be able to work well together.

Since the way data was transferred between the models was quite complex, this process is better followed using a flow chart.

An initial guess is made. To save computation time, this was an expected racing line. The path is then created using methods outlined in section 4. The tire friction are then calculated based on velocity estimates based on the curvature, this is outlined in section 5. These tire friction at every point are then sent to the vehicle dynamic model. This outputs velocity bounds at every point. These bound are then passed to the powertrain which optimizes the gear changes to minimize the time around the track. The gradients are then calculated by varying the track geometry at every gate minutely and then storing that difference. The gates are then moved to minimize the time around the track. The step size is controlled by the Armijo line search. This is repeated until a time is found that is faster than the guess at the beginning of each step.

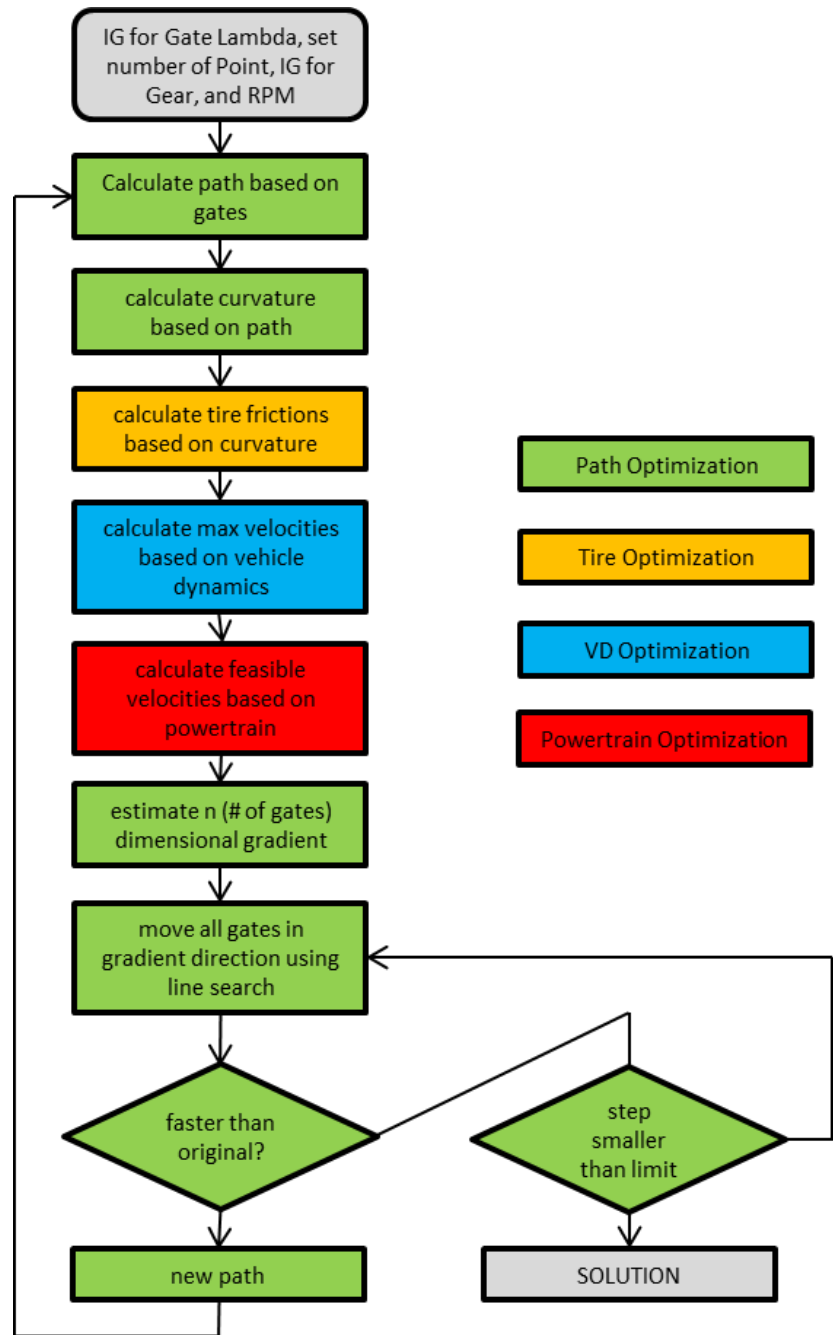

This is terminated once a local minimum is found. This is determined when an extremely small change in gates in the direction of the gradient produces no advantage.

8.1 AIO Approach

Finally, our optimization achieved real, realistic results. For the path, the results showed that in certain sectors the curvature was minimized, in others the shortest path was taken. This is especially apparent in turn 1. To maximize curvature the turn could have been taken slightly wider. This however increased the distance, which increased the race time.

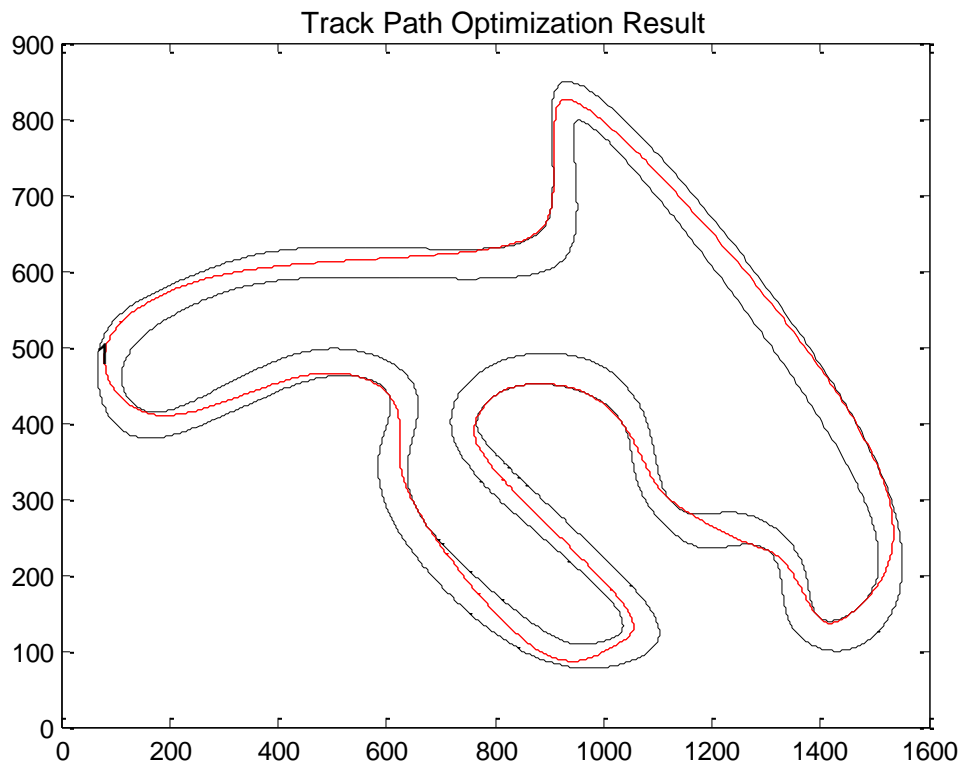

Figure 8.1.1: Outline of the best local minimum.

Discussion: This was found based on an initial guess that was close to a racing line. The result was ~5 seconds faster than the best solution by hand. This is very close to an accepted 'racing line.' This solution is affected by the location of the gates. The solution can change based on where they are.

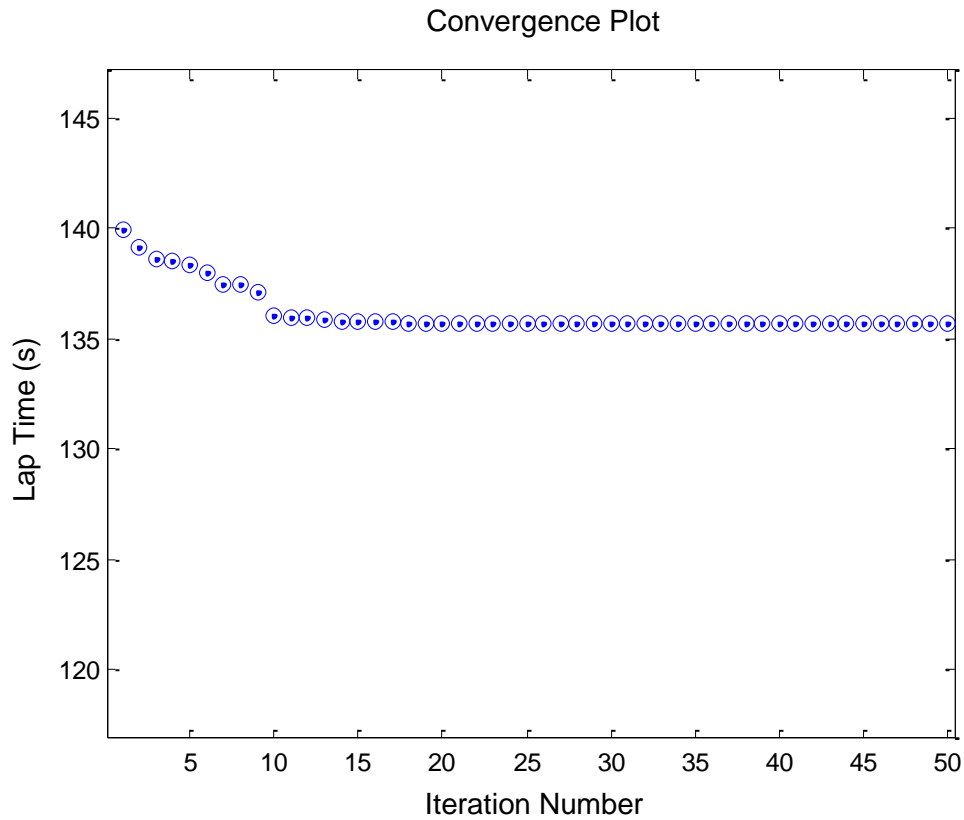

Figure 8.1.2: Plot of the convergence of the racing line on a local solution.

Discussion: The initial guess was as close to a racing line as possible by hand and experience. The search was terminated after 50 iterations based on the convergence criteria, that the Armijo line search failed to reach a better solution.

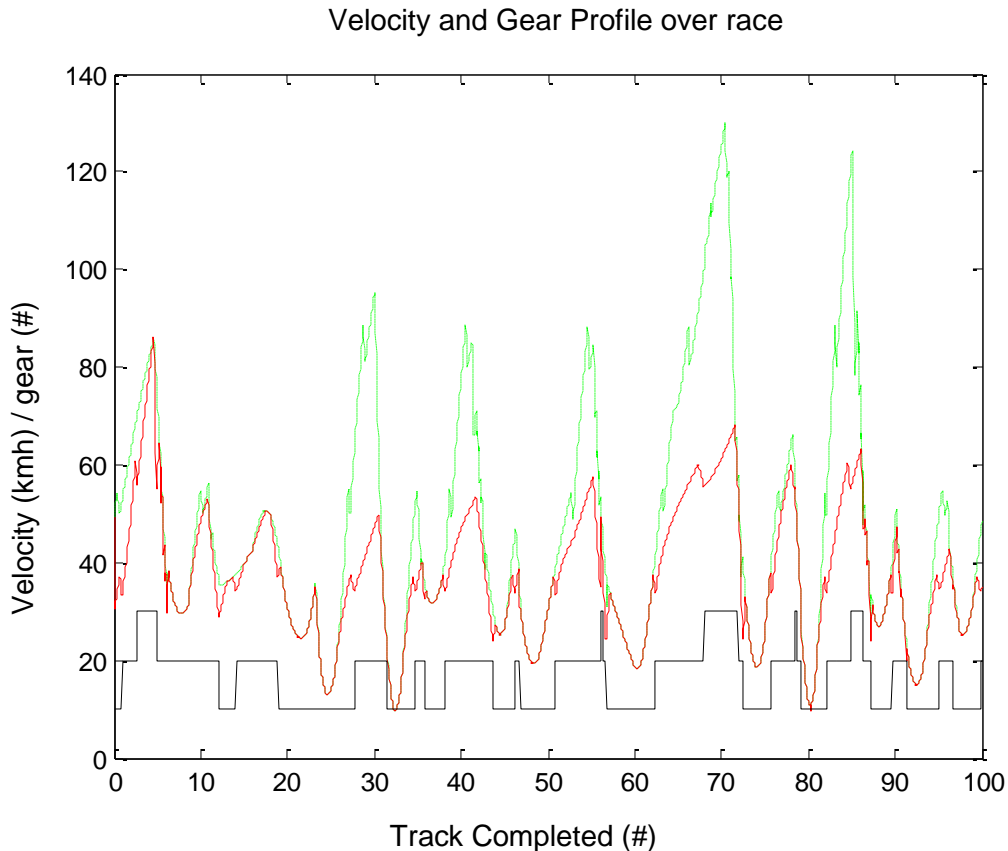

Figure 8.1.3: Plot of the convergence of the racing line on a local solution. The green line is the Vehicle Dynamic Bound, the red line is the achievable velocity, and the black line is the gear at each point.

Discussion: This profile shows the distribution of the velocities around the track. In most cases this is bounded by the vehicle dynamic bounds. However when it isn't the effect of full being at full throttle can be seen. The gear changes appear feasible across the board, and don't oscillate.

8.2 Usability of Results and Future Work

The racing line results are much better than expected at the beginning of the project. More options should be considered by changing the locations of the gates.

The results for the gear changes are all dependent on the powertrain, which, as it wasn't the focus of this study, could have been better. To turn this into a usable model the following should be done. Create and validate good models of the car. Incorporate surface conditions such as temperature, roughness, wetness and elevation of the track. If these are correct this could be a very useful tool.

9. References

C.H.A. Criens, T. ten Dam, H.J.C. Luijten, T. Rutjes, *Building a MATLAB based Formula Student Simulator*. Technische Universiteit Eindhoven. June 20, 2006

D Bastow. "Car Suspension and Handling, 2nd edition". In: SAE (1987).

David A. Crolla. "Automotive Engineering" Powertrain, Chassis System and Vehicle Body". In: *Automotive Engineering* (2009), pp. 107–125.

Honda R&D America, *Vehicle Dynamics and Simulation "Vehicle Dynamics Simulation for Predicting Steering Power-Off limit Performance"*. SAE International 2008.

John B. Heywood. "Internal Combustion Engine Fundamentals". In: *Mechanical Engineering* (1988), pp. 49–55.

Rajesh Rajamani, *Vehicle Dynamics and Control*. University of Minnesota 2006.

Thomas D. Gillespie. "Fundamentals of Vehicle Dynamics". In: *Society of Automotive Engineers*, pp. 79–120.

Ying Xiong, *Racing Line Optimization*. Massachusetts Institute of Technology. September 2010.

Jones, D. R., C. D. Perttunen, and B. E. Stuckman. "Lipschitzian Optimization without the Lipschitz Constant." *Journal of Optimization Theory and Applications* 79.1 (1993): 157-81.

Venkataraman, P. *Applied Optimization with MATLAB Programming*. New York: Wiley, 2002. Print.

MacIsaac J., & Riley G. (2002). *Preliminary Findings of the Effect of Tire Inflation Pressure on the Peak and Slide Coefficients of Friction*. Report No.: DOT HS 809428. United States. US Department of Transportation.

10. Appendix

10.1 Vehicle Dynamics Modifications

The vehicle dynamics model was completely modified from the original method of analysis. Originally, our global system was to be modeled using a finite element method, in which the total accumulated force was to be calculated at each point and decide how the next integration point would affect each decision to be made. In order to accurately model the vehicle dynamics for this original idea was to focus heavily on the tire forces, which included steering angle, front tire turning modeling, power delivery, contact area size, immediate pressures and force history. The original system of equations took all of these subsystems into account and was to be modeled as the link between the tire and powertrain analysis to the track geometry. The equations to be used for the original can be found in section 10.2

10.2 Original Vehicle Dynamics Model (Suspension)

Nomenclature:

l_f	Longitudinal Distance from C.G. to Front Tires	[m]
l_r	Longitudinal Distance from C.G. to Rear Tires	[m]
Ψ	Yaw	[m]
m	Mass	[kg]
δ	Steering Angle	[degree]
ω_w	Wheel Angular Velocity	[rev/sec]
\dot{x}	Longitudinal Velocity	[m/s]
\ddot{x}	Longitudinal Acceleration	[m/s ²]
\dot{y}	Lateral Velocity	[m/s]
\ddot{y}	Lateral Acceleration	[m/s ²]

The governing equations for the original vehicle dynamics model are defined by the sum of the longitudinal and lateral forces, respectively:

$$m\ddot{x} = (F_{xfl} + F_{xfr}) \cos(\delta) + F_{xrl} + F_{xrr} - (F_{yfl} + F_{yfr}) \sin(\delta) + m\dot{\Psi}\dot{y} \quad (1)$$

$$m\ddot{y} = F_{yrl} + F_{yrr} + (F_{xfl} + F_{xfr}) \sin(\delta) + (F_{yfl} + F_{yfr}) \cos(\delta) - m\dot{\Psi}\dot{x} \quad (2)$$

The longitudinal tire forces are defined as:

$$F_{xxx} = C \frac{r_{eff}\omega_w - \dot{x}}{r_{eff}\omega_w} \quad (3)$$

The lateral tire forces are defined as:

$$F_{yxx} = C_a \left(\delta - \tan^{-1} \left(\frac{\dot{y} + l_f \dot{\Psi}}{\dot{x}} \right) \right) \quad (4)$$

Where δ equals zero for the rear tires (Assuming front steering only).

The mathematical model is defined as follows:

Minimize: Equation (2) (Angular Acceleration)

Subject to: Equation (4) < (Traction Input)

Where δ is a variable, \dot{x} and \dot{y} arise from powertrain inputs

$$\delta < 30^\circ$$

Assumptions:

Front wheel steering

Constant tire contact with pavement (No tilt steering)

No body roll (Stiff chassis)